

This drawing and design is protected by copyright and the information is confidential. It is also protected and registered under Dutch laws through the Dutch government department for taxes. The drawing and/or models may not to copied, reproduced, duplicated or disclosed to others, in whole or in part without prior written consent of Rob Snel B.V./the Netherlands

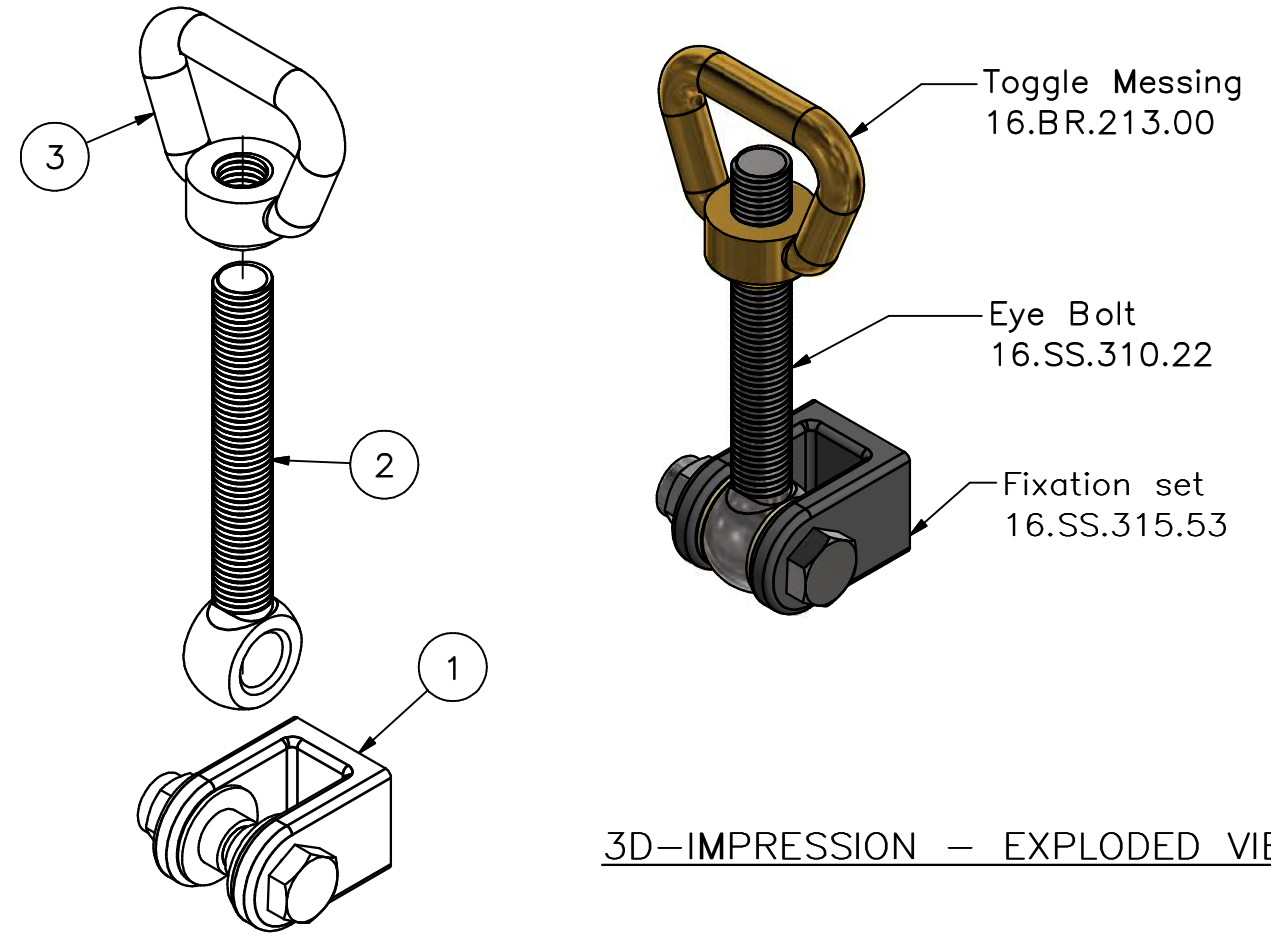
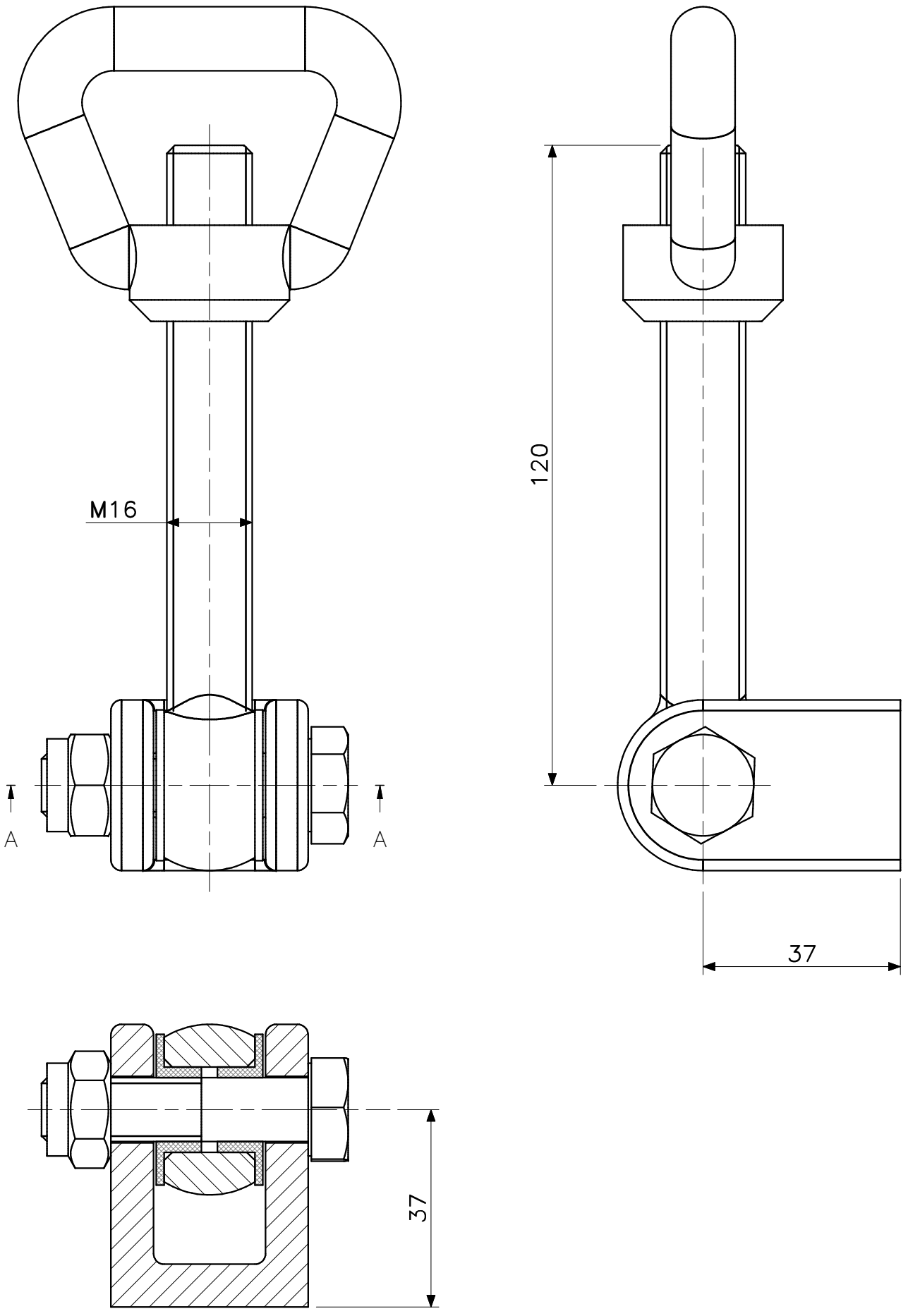

POS	QTY	TITLE	MATERIAL	DIMENSION	DWG NR
3	1	TOGGLE M16 MESSING	Messing	M16	16.BR.213.00
2	1	EYE BOLT M16x120 STAINLESS STEEL	Stainless Steel	M16x120	16.SS.310.22
1	1	Fixation Set	Stainless Steel		16.SS.315.53

Rev.:	REV. DATE:	REVISION SUBJECT
Date:	22-7-2021	
Drawn:	Hans Baars	
Scale:	1:1	
Status:	Pending	
Cust.:		
Project:		

		Rob Snel Technische Groothandel Industrieweg 39 3361 HJ Sliedrecht	Art.nr:
		T +31 (0)184 43 30 30 F +31 (0)184 43 30 31 E s.snel@robsnel.nl I www.robsnel.nl	Projection type: 

Title: Assembly M16 Toggle nut - Eye bolt - Fixation set				
Mat:	Dwg.nr:	Revision:	Sheet:	Format:
	16.SS.021.12		1	A3